

ACEMI TECHNOLOGY CORP. LTD.

(TFT LCD MODULE Manufacture)

Tel: (852) 2764 7415 .

Fax: (852) 2333 5979 .

E-mail:leolam@silicone.com.hk .

**COLOR TFT-LCD
PRELIMINARY SPECIFICATION**

MODEL NAME: _____

The content of this technical information
is subject to change without notice.
Please contact Unipac or its agent for
further information.

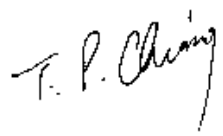
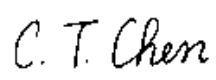
Approved by	Checked by	Prepared by
		

Contents:

A. Physical specifications	P3
B. Electrical specifications	P4
1. Pin assignment	P4
a. TFT-LCD panel driving section	P4
b. Backlight driving section	P5
2. Absolute maximum ratings	P5
3. Electrical characteristics	P6
a. Typical operating conditions	P6
b. Current consumption	P6
c. Backlight driving conditions	P6
4. AC Timing	P7
a. Timing conditions	P7
b. Timing diagram	P7
C. Optical specifications	P8
D. Reliability test items	P10
E. Packing form	P11

Appendix:

Fig.1 Outline dimension of TFT-LCD module	P12
Fig.2 Sampling clock timing	P13
Fig.3 Horizontal display timing range	P14
Fig.4-(a) Horizontal timing	P15
Fig.4-(b) Detail horizontal timing	P16
Fig.5 Vertical shift clock timing	P17
Fig.6-(a) Vertical timing (From up to down)	P18
Fig.6-(b) Vertical timing (From down to up)	P19

A.Physical specifications

NO.	Item	Specification	Remark
1	Display resolution(dot)	480(W) × 234(H)	
2	Active area(mm)	82.1(W) × 61.8(H)	
3	Screen size(inch)	4.05(Diagonal)	
4	Dot pitch(mm)	0.171(W) × 0.264(H)	
5	Color configuration	R.G.B delta	
6	Overall dimension(mm)	96.0(W) × 76.0(H) × 6.5(D)	Note 1
7	Weight(g)	(65±20)	

Note 1 : Refer to Fig. 1

B.Electrical specifications

1.Pin assignment

a. TFT-LCD panel driving section

Pin no.	Symbol	i/o	Description	Remark
1	GND	-	Ground for logic circuit	
2	V _{CC}	i	Supply voltage for logic control circuit for scan driver	
3	V _{GL}	i	Negative power for scan driver	
4	V _{GH}	i	Positive power for scan driver	
5	STVR	i/o	Vertical start pulse	Note 1
6	STVL	i/o	Vertical start pulse	Note 1
7	CKV	i	Shift clock input for scan driver	
8	U/D	i	UP/DOWN scan control input	Note 1,2
9	OEV	i	Output enable input for scan driver	
10	VCOM	i	Common electrode driving signal	
11	VCOM	i	Common electrode driving signal	
12	L/R	i	LEFT/RIGHT scan control input	Note 1,2
13	Q1H	i	Analog signal rotate input	
14	OEH	i	Output enable input for data driver	
15	STHL	i/o	Start pulse for horizontal scan line	Note 1
16	STHR	i/o	Start pulse for horizontal scan line	Note 1
17	CPH3	i	Sampling and shifting clock pulse for data driver	
18	CPH2	i	Sampling and shifting clock pulse for data driver	
19	CPH1	i	Sampling and shifting clock pulse for data driver	
20	V _{CC}	i	Supply voltage of logic control circuit for data driver	
21	GND	-	Ground for logic circuit	
22	VR	i	Alternated video signal input(Red)	
23	VG	i	Alternated video signal input(Green)	
24	VB	i	Alternated video signal input(Blue)	
25	AV _{DD}	i	Supply voltage for analog circuit	
26	AV _{SS}	-	Ground for analog circuit	

Note 1 : Selection of scanning mode

Setting of scan control input		IN/OUT state for start pulse				Scanning direction
U/D	L/R	STVR	STVL	STHR	STHL	
GND	V _{CC}	OUT	IN	OUT	IN	From up to down, and from left to right.
V _{CC}	GND	IN	OUT	IN	OUT	From down to up, and from right to left.
GND	GND	OUT	IN	IN	OUT	From up to down, and from right to left.
V _{CC}	V _{CC}	IN	OUT	OUT	IN	From down to up, and from left to right.

IN: Input; OUT: Output.

Note 2 : Definition of scanning direction.

Refer to figure as below:

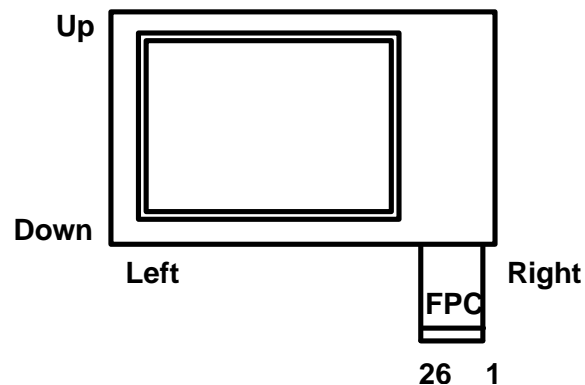

b. Backlight driving section(Refer to Fig.1)

No.	Symbol	I/O	Description	Remark
1	HI	i	Power supply for backlight unit (High voltage)	
2	GND	-	Ground	

2. Absolute maximum ratings

Item	Symbol	Condition	Min.	Max.	Unit	Remark
Power voltage	V _{CC}	GND=0	-0.3	7	V	
	AV _{DD}	AV _{SS} =0	-0.3	7	V	
	V _{GH}	GND=0	-0.3	18	V	
	V _{GL}		-15	0.3	V	
	V _{GH} - V _{GL}		-	31	V	
Input signal voltage	V _i		-0.3	AV _{DD} +0.3	V	Note 1
	V _l		-0.3	V _{CC} +0.3	V	Note 2
	V _{COM}		-2.9	5.2	V	
Operating temperature	T _{opa}		0	60	°C	Ambient temperature
Storage temperature	T _{stg}		-25	80	°C	Ambient temperature

Note 1: VR, VG, VB

Note 2: STHL, STHR, Q1H, OEH, L/R, CPH1 ~ CPH3, STVR, STVL, OEV, CKV, U/D

3. Electrical characteristics

a. Typical operating conditions (GND=AV_{SS}=0V , Note 5)

Item		Symbol	Min.	Typ.	Max.	Unit	Remark
Power supply		V _{CC}	4.8	5	5.2	V	
		AV _{DD}	4.8	5	5.2	V	
		V _{GH}	14.3	15	15.7	V	
		V _{GLAC}	3.5	5	7.5	Vp-p	AC component of V _{GL} , Note 1
		V _{GLDC}	-10.5	-10	-9.5	V	DC component of V _{GL}
Video signal amplitude (VR, VG, VB)		V _{iA}	AV _{SS} +0.4	-	AV _{DD} -0.8	V	Note 2
		V _{iAC}	-	3	-	V	AC component
		V _{iDC}	-	AV _{DD} /2	-	V	DC component
VCOM		V _{CAC}	3.5	5	7.5	Vp-p	AC component, Note 3
		V _{CDC}	-	1.3	-	V	DC component
Input signal voltage	H Level	V _{IH}	4	-	V _{CC}	V	Note 4
	L Level	V _{IL}	0	-	1	V	

Note 1: The same phase and amplitude with common electrode driving signal(VCOM).

Note 2: Refer to Fig.4-(a)

Note 3: The brightness of LCD panel could be changed by adjusting the AC component of VCOM.

Note 4: STHL, STHR, Q1H, OEH, L/R, CPH1 ~ CPH3, STVR, STVL, OEV, U/D, CKV .

Note 5: Be sure to apply GND , V_{CC} , V_{GL} to the LCD first , and then apply V_{GH} .

b. Current consumption (GND=AV_{SS}=0V)

Parameter	Symbol	Condition	Min.	Typ.	Max.	Unit	Remark
Current for driver	I _{GH}	V _{GH} =15V	-	80	150	μA	
	I _{GL}	V _{GL} = -10V	-	-0.2	-0.4	mA	
	I _{CC}	V _{CC} =5V	-	2.0	4.0	mA	
	I _{DD}	AV _{DD} =5V	-	5	10	mA	

c. Backlight driving conditions

Parameter	Symbol	Min.	Typ.	Max.	Unit	Remark
Lamp voltage	V _L	260	290	320	Vrms	
Lamp current	I _L	2.5	2.9	3.3	mArms	
Frequency	F _L	55	60	65	KHz	
Lamp Starting voltage	V _s	-	-	580	Vrms	Note 1
		-	-	870	Vrms	Note 2

Note 1: Ta = 25 °C

Note 2: Ta = 0 °C

4.AC Timing

a.Timing conditions

Parameter	Symbol	Min.	Typ.	Max.	Unit.	Remark
Rising time	t_r	-	-	10	ns	Note 1
Falling time	t_f	-	-	10	ns	Note 1
High and low level pulse width	t_{CPH}	299	308	319	ns	CPH1~CPH3
CPH pulse duty	t_{CWH}	40	50	60	%	CPH1~CPH3
CPH pulse delay	t_{C12} t_{C23} t_{C31}	70	$t_{CPH}/3$	$t_{CPH}/2$	ns	CPH1; CPH3
STH setup time	t_{SUH}	35	-	-	ns	STHR,STHL
STH hold time	t_{HDH}	35	-	-	ns	STHR,STHL
STH pulse width	t_{STH}	-	1	-	t_{CPH}	STHR,STHL
STH period	t_H	61.5	63.5	65.5	μS	STHR,STHL
OEH pulse width	t_{OEH}	-	3	-	t_{CPH}	OEH
Sample and hold disable time	t_{DIS1}	-	28	-	t_{CPH}	
OEV pulse width	t_{OEV}	-	12	-	t_{CPH}	OEV
CKV pulse width	t_{CKV}	16	28	40	t_{CPH}	CKV
Clean enable time	t_{DIS2}	-	10	-	t_{CPH}	
Horizontal display start	t_{SH}	-	0	-	$t_{CPH}/3$	
Horizontal display timing range	t_{DH}	-	480	-	$t_{CPH}/3$	
STV setup time	t_{SUV}	400	-	-	ns	STVL,STVR
STV hold time	t_{HDV}	400	-	-	ns	STVL,STVR
STV pulse width	t_{STV}	-	-	1	t_H	STVL,STVR
Horizontal lines per field	t_V	256	262	268	t_H	Note 2
Vertical display start	t_{SV}	-	3	-	t_H	
Vertical display timing range	t_{DV}	-	234	-	t_H	
VCOM rising time	t_{rCOM}	-	-	3	μS	
VCOM falling time	t_{fCOM}	-	-	3	μS	
VCOM delay time	t_{DCOM}	-	-	3	μS	
RGB delay time	t_{DRGB}	-	-	1	μS	

Note 1: For all of the logic signals.

Note 2: Please don't use odd horizontal lines to drive LCD panel for both odd and even field simultaneously.

b.Timing diagram

Please refer to the attached drawing, from Fig.2 to Fig.6.

C.Optical specifications (Note 1,Note 2, Note 3)

Item	Symbol	Condition	Min.	Typ.	Max.	Unit	Remark
Response time	Rise	$\theta = 0^\circ$	-	25	50	ms	Note 4,6
	Fall		-	30	60	ms	
Contrast ratio	CR	At optimized viewing angle	60	150			Note 5,6
Viewing angle	Top	$CR \geq 10$	10	-	-	deg.	Note 6,7
	Bottom		30	-	-		
	Left		45	-	-		
	Right		45	-	-		
Brightness	Y_L	$\theta = 0^\circ$	210	250	-	nit	Note 8
White chromaticity	x	$\theta = 0^\circ$	0.25	0.30	0.35		Note 8
	y		0.30	0.35	0.40		

- Note 1. Ambient temperature = 25 °C, and lamp current $I_L=2.9mA$ rms.
 Note 2. To be measured in the dark room.
 Note 3. To be measured on the center area of panel with a viewing cone of 1° by Topcon luminance meter BM-7, after 10 minutes operation.
 Note 4. Definition of response time:
 The output signals of photodetector are measured when the input signals are changed from "black" to "white"(falling time) and from "white" to "black"(rising time),respectively.
 The response time is defined as the time interval between the 10% and 90% of amplitudes. Refer to figure as below.

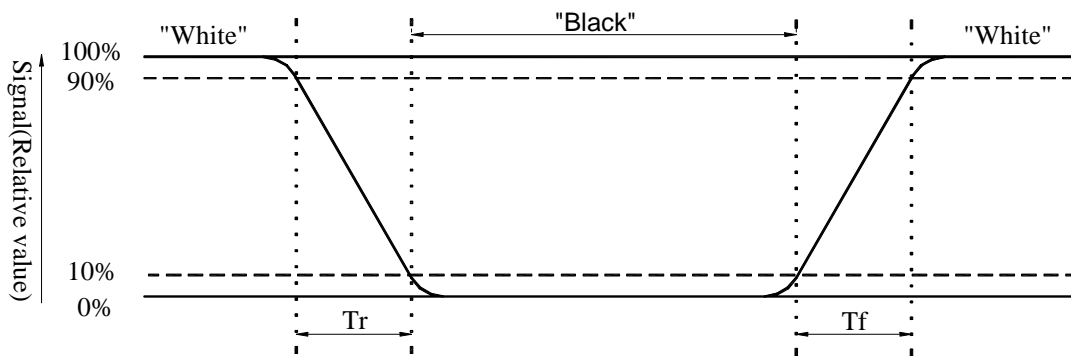

- Note 5. Definition of contrast ratio:
 Contrast ratio is calculated with the following formula.

$$\text{Contrast ratio (CR)} = \frac{\text{Photodetector output when LCD is at "White" state}}{\text{Photodetector output when LCD is at "Black" state}}$$

Note 6. White $V_i = V_{i50} \mp 1.5V$
Black $V_i = V_{i50} \pm 2.0V$

' \pm ' means that analog input signal swings in phase with COM signal.

' \mp ' means that analog input signal swings out of phase with COM signal.

V_{i50} : The analog input voltage when transmission is 50%.

The 100% transmission is defined as the transmission of LCD panel when all the input terminals of module are electrically opened.

Note 7. Definition of viewing angle:
Refer to figure as below.

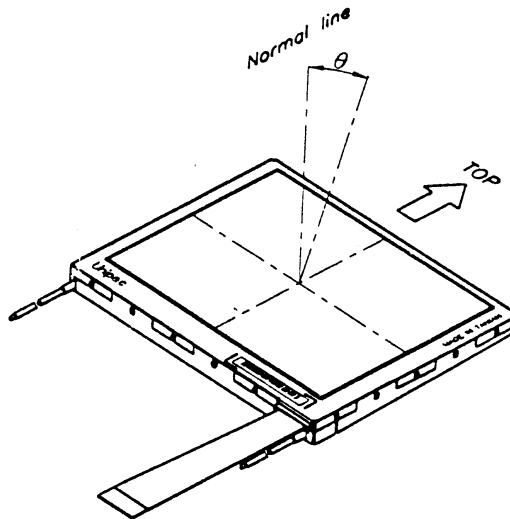

Note 8. Measured at the center area of the panel when all the input terminals of LCD panel are electrically opened.

D.Reliability test items:

No.	Test items	Conditions	Remark
1	High temperature storage	Ta = 80°C 240H	
2	Low temperature storage	Ta = -25°C 240H	
3	High temperature operation	Ta = 60°C 240H	
4	Low temperature operation	Ta = 0°C 240H	
5	High temperature and high humidity	Ta = 60°C · 95%RH 240H	Operation
6	Heat shock	-25°C ~ +80°C/50 cycles 2H/cycle	Non-operation
7	Electrostatic discharge	± 200V, 200pF(0Ω),once for each terminal	Non-operation
8	Vibration	Frequency range:10 ~ 55Hz Stroke :1.5mm Sweep :10j 55Hz ~ 10Hz 2 hours for each direction of X,Y,Z (6 hours for total)	JIS C7021,A-10 condition A
9	Mechanical shock	100G · 6ms, ±X, ±Y, ± Z 3 times for each direction	JIS C7021,A-7 condition C
10	Vibration (with carton)	Random vibration: 0.015G ² /Hz from 5 ~ 200Hz -6dB/Octave from 200 ~ 500Hz	IEC 68-34
11	Drop (with carton)	Height: 80cm 1 corner,3 edges,6 surfaces	

Note: Ta: Ambient temperature.

E. Packing form

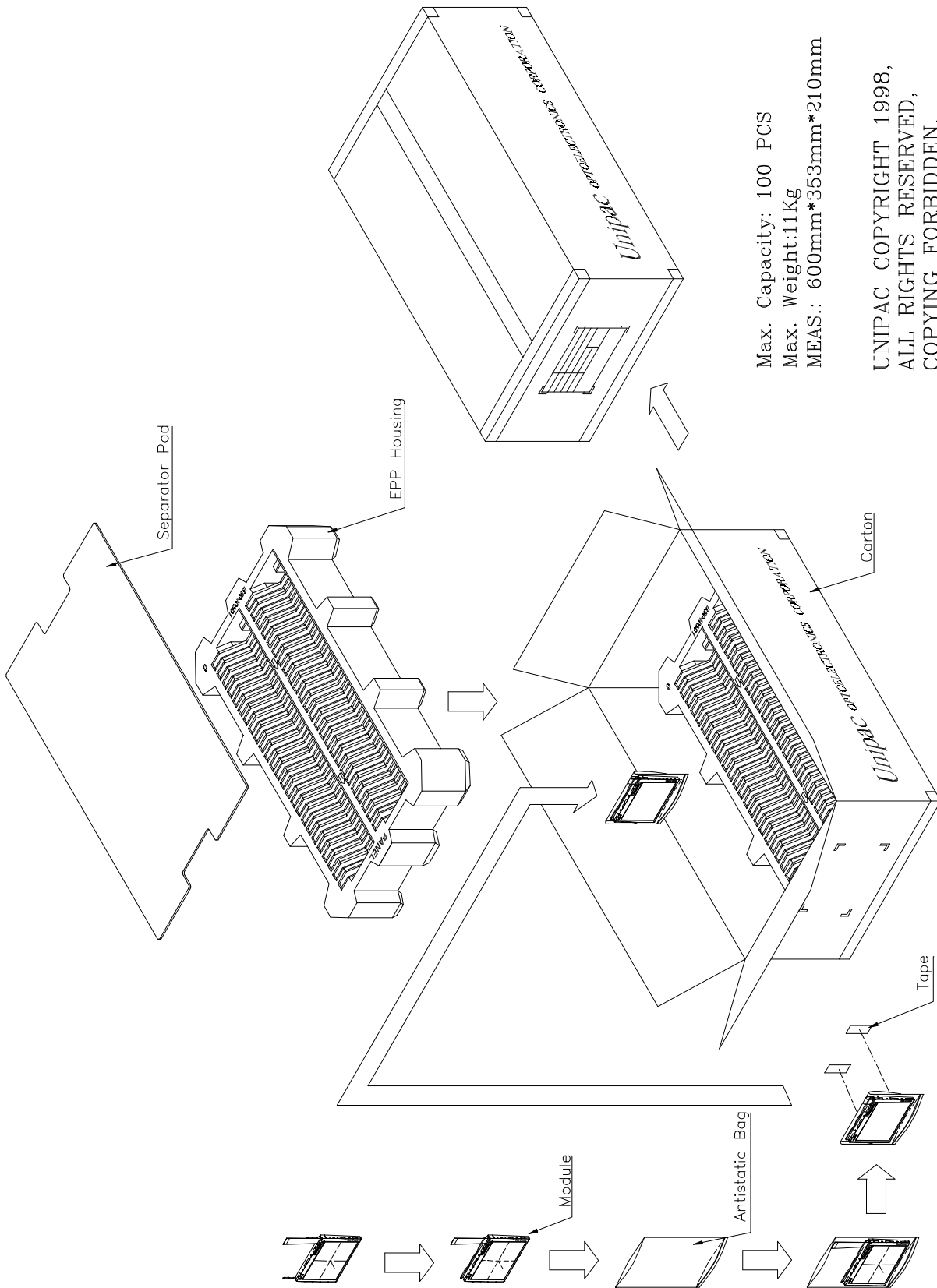

- NOTES :
1. General tolerance ± 0.3 .
 2. The bending radius of FPC should be larger than 0.6.
 3. Unit : mm

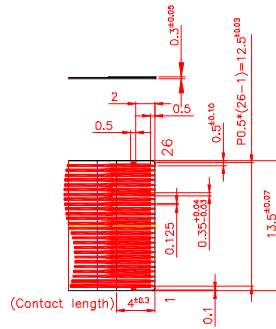

UNIPAC COPYRIGHT 1999,
 ALL RIGHTS RESERVED,
 COPYING FORBIDDEN.

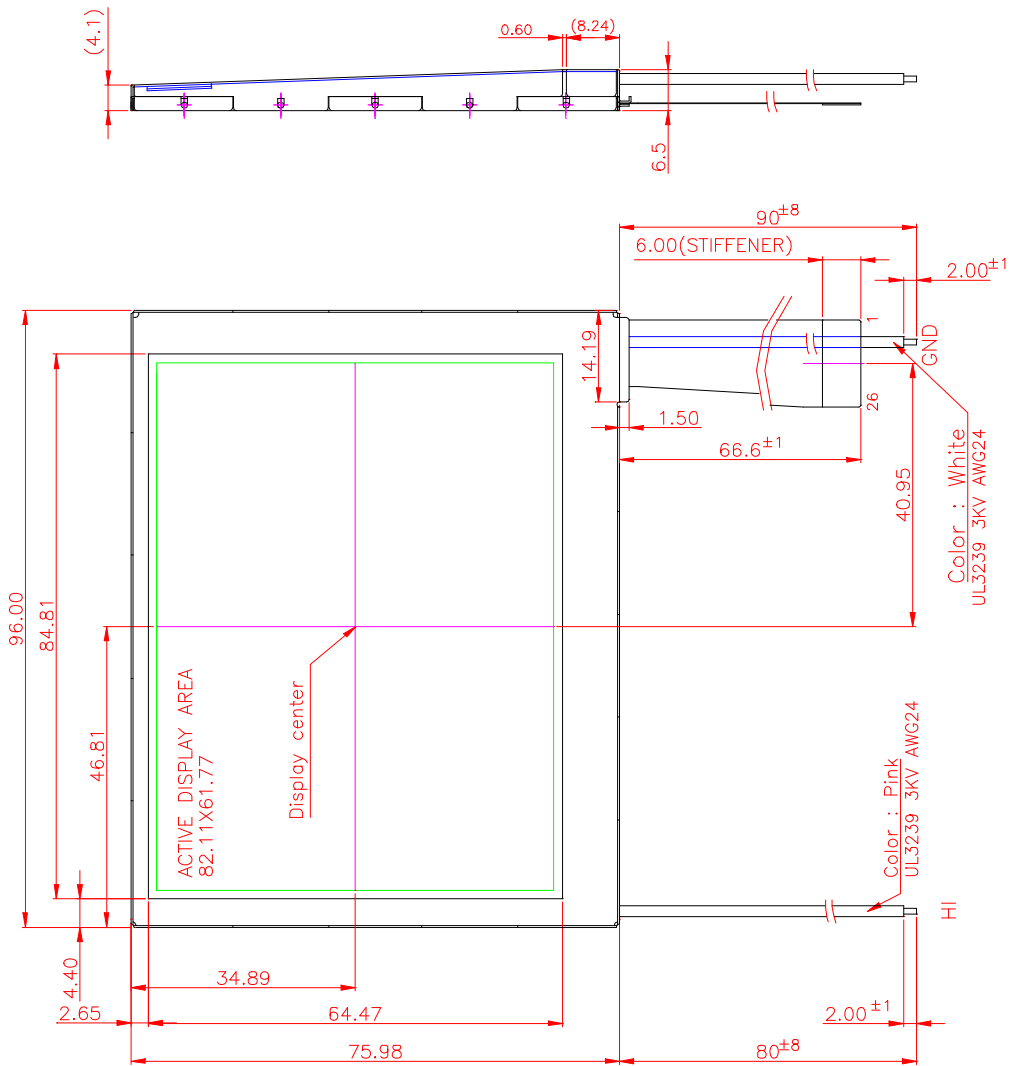

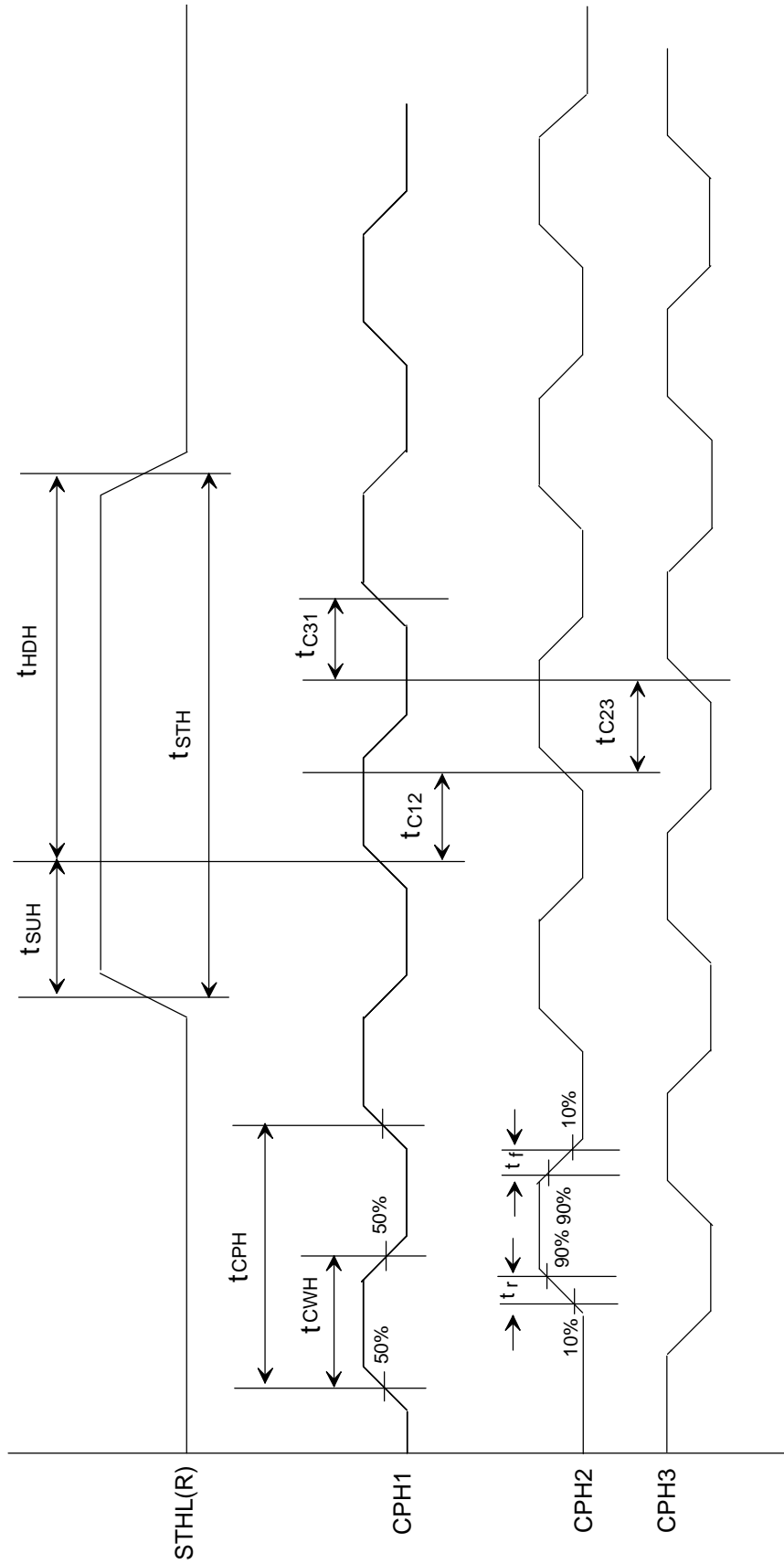

Fig.2 Sampling clock timing

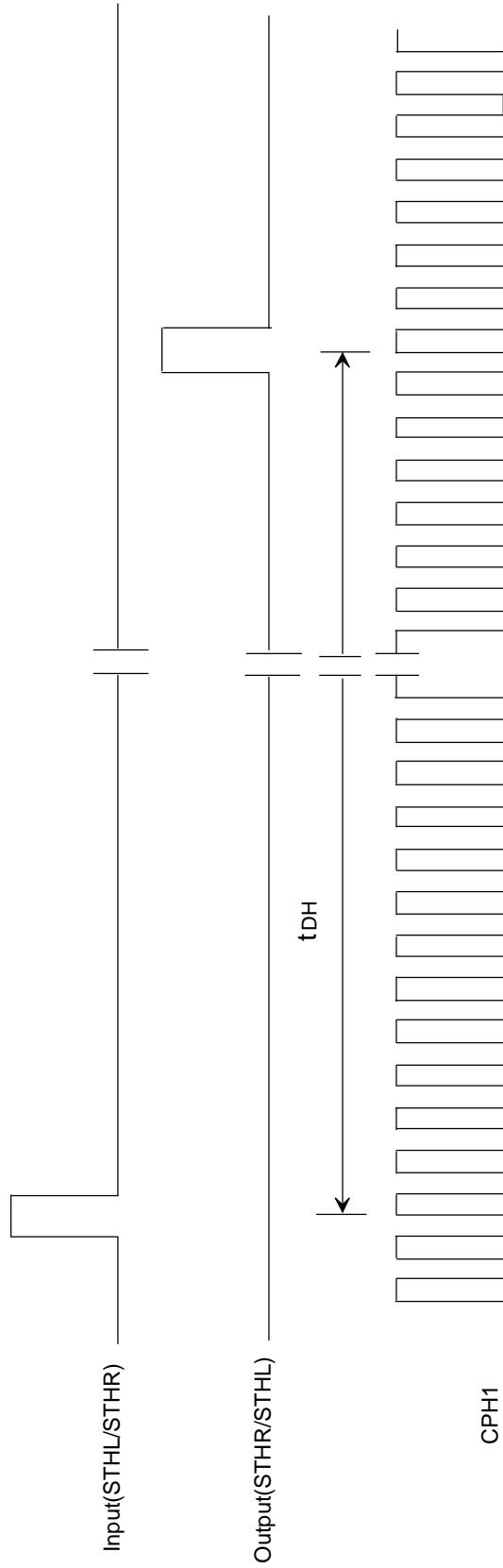

Fig.3 Horizontal display timing range

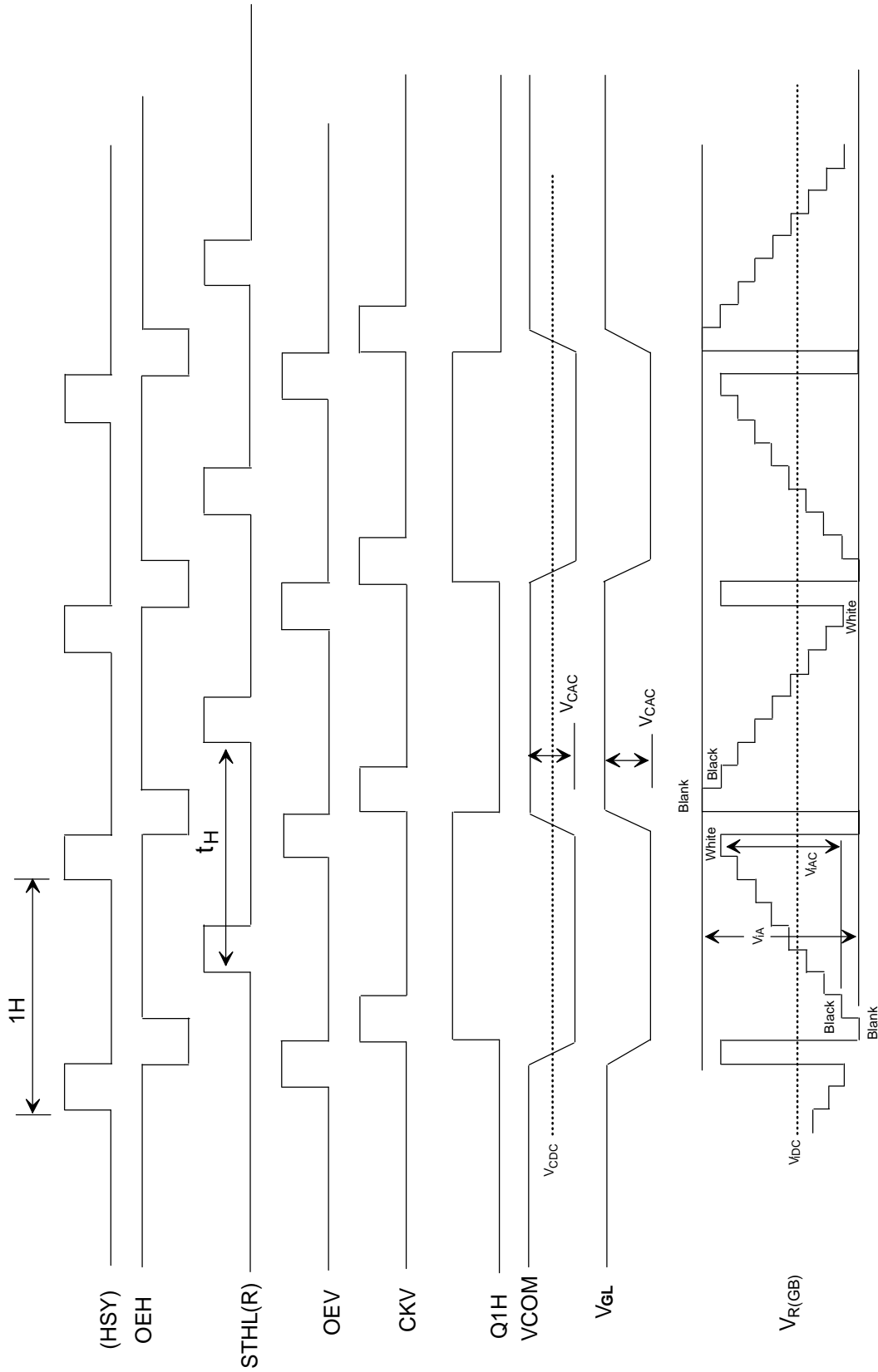
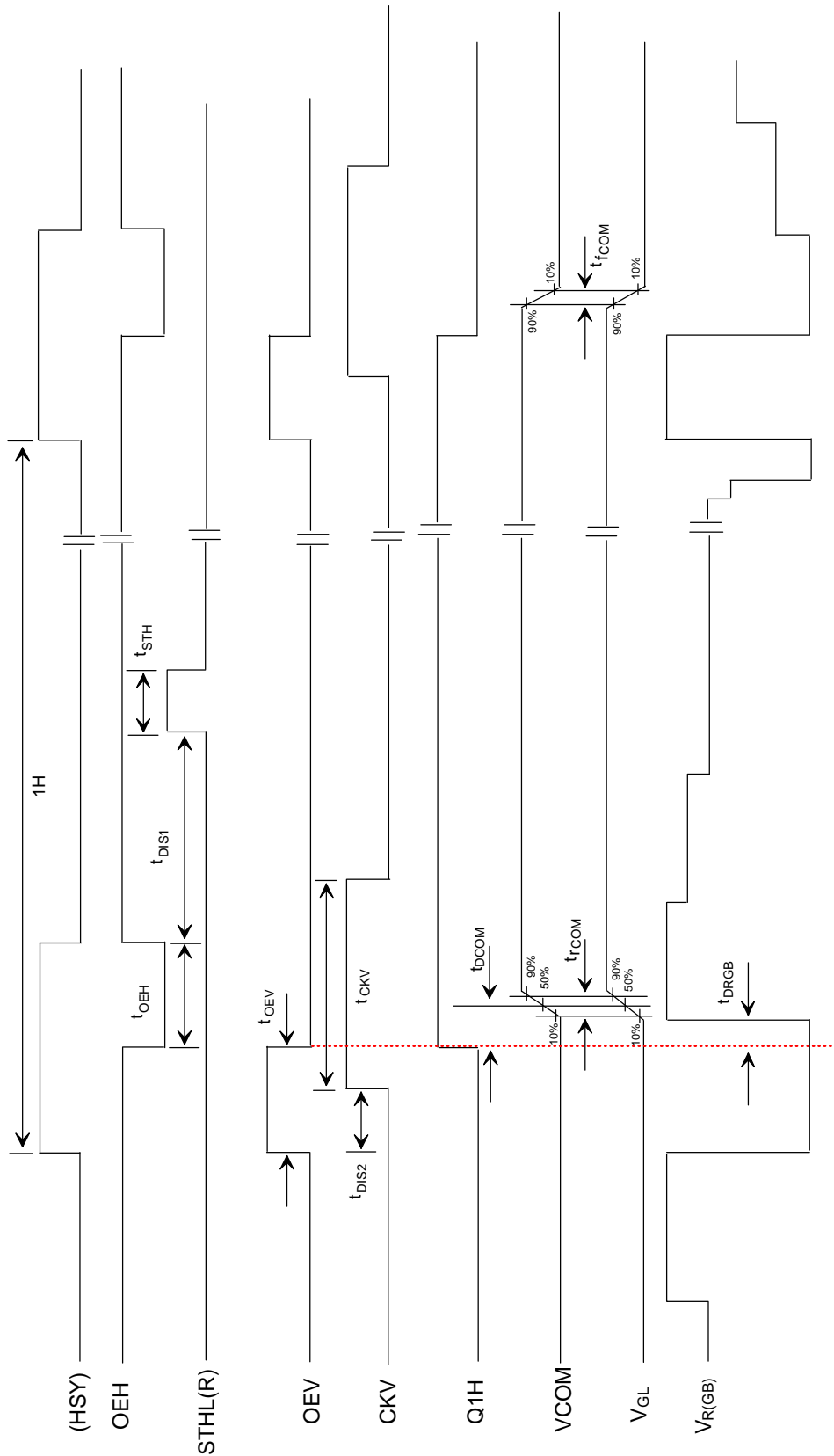

Fig.4-(a) Horizontal timing



Note: The rising edge of Q1H and the falling edge of OEV should be synchronized with the falling edge of OEH

Fig.4-(b) Detail horizontal timing

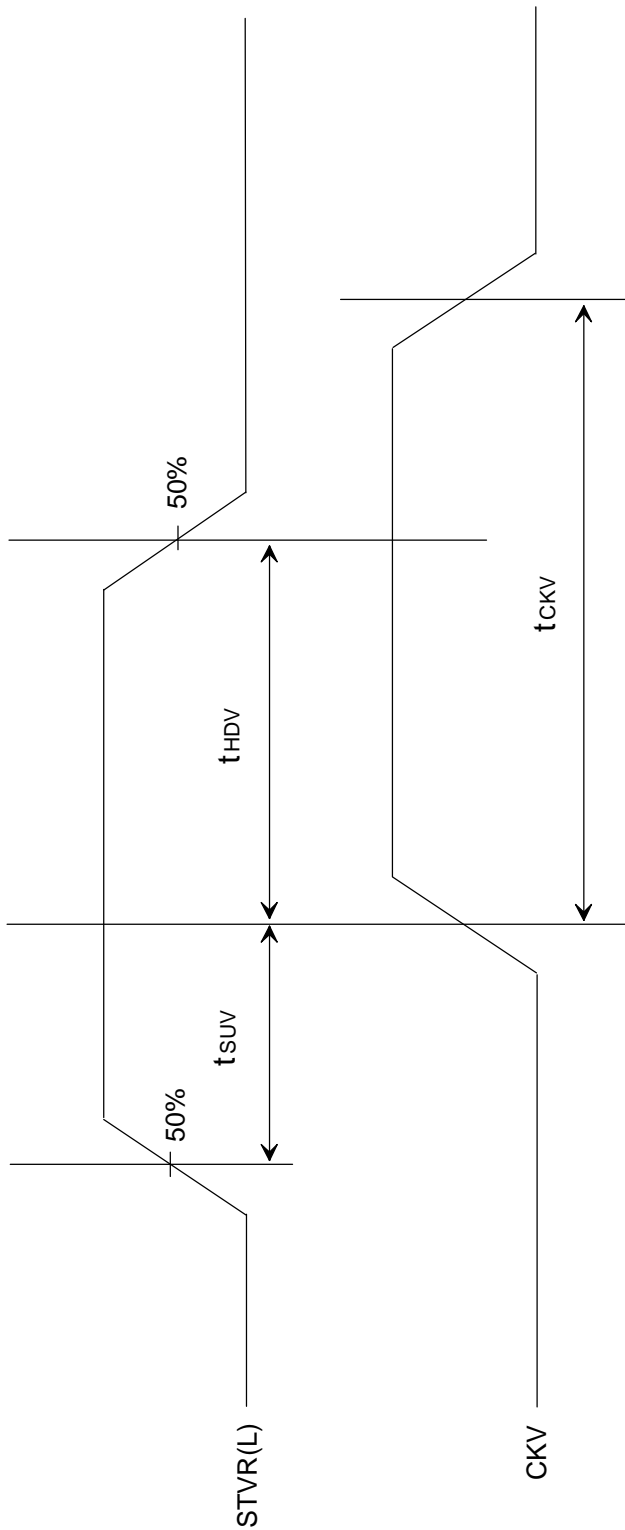

Fig.5 Vertical shift clock timing

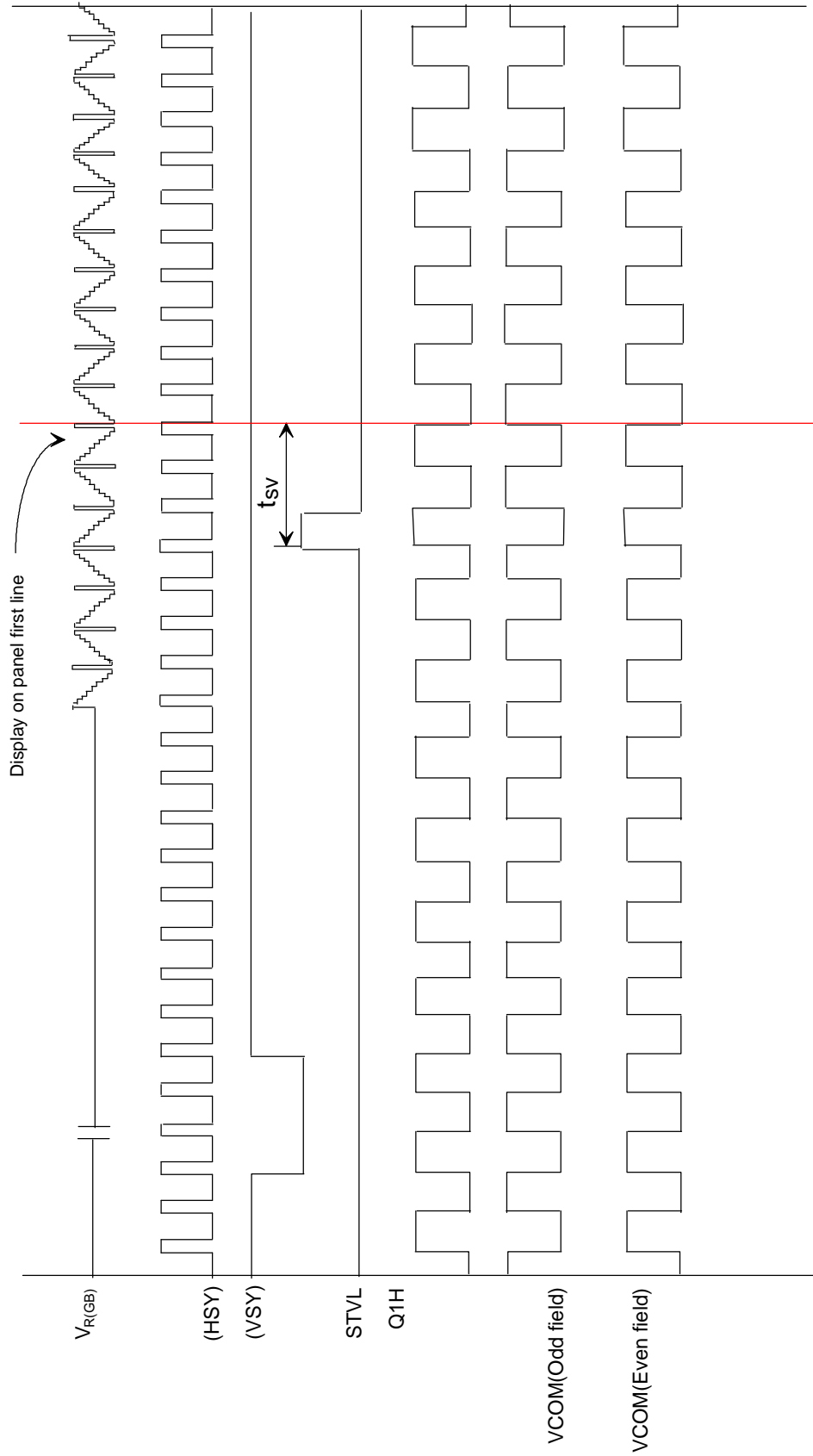

Fig.6-(a) Vertical timing (From up to down)

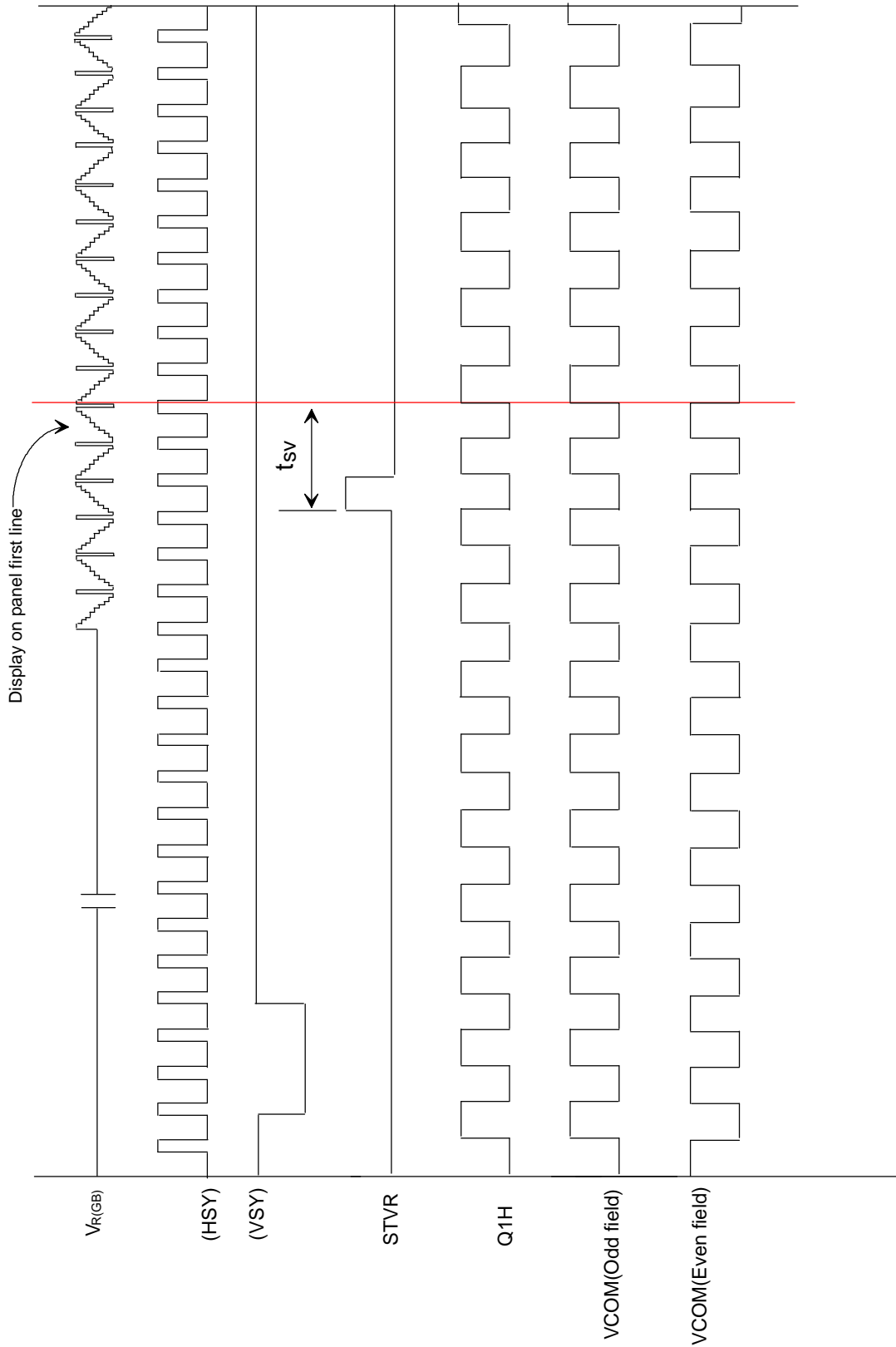

Fig.6-(b) Vertical timing (From down to up)

UNIPAC OPTOELECTRONICS CORPORATION

TERMS AND CONDITIONS OF SALE

(Revision: January 1996)

These Terms and Conditions of Sale apply to all items designed and/or made by Unipac Optoelectronics Corporation ("Unipac"), and Buyer agrees they apply to all such items.

1. ACCEPTANCE OF TERMS

BUYER ACCEPTS THESE TERMS (i) BY WRITTEN ACCEPTANCE (BY PURCHASE ORDER OR OTHERWISE), OR (ii) BY FAILURE TO RETURN GOODS DESCRIBED ON THE FACE OF THIS FORM WITHIN FIVE DAYS OF THEIR DELIVERY.

2. DELIVERY

- a. Delivery will be made Free Carrier (Incoterms), Unipac's warehouse, Science-Based Industrial Park, Taiwan.
- b. Title to the goods and the entire risk will pass to Buyer upon delivery to carrier.
- c. Shipments are subject to availability. Unipac shall make every reasonable effort to meet the date (s) quoted or acknowledged; and if Unipac makes such effort, Unipac will not be liable for any delays.

3. TERMS OF PAYMENT

- a. Terms are as stated on Unipac's quotation, or if none are stated, net forty-five (45) days. Accounts past due will incur a monthly charge at the rate of one and one-half percent (1.5%) per month (or, if less, the maximum allowed by applicable law) to cover servicing costs.
- b. Unipac reserves the right to change credit terms at any time in its sole discretion.

4. LIMITED WARRANTY

- a. Unipac warrants that the goods sold will be free from defects in material and workmanship and comply with Unipac's applicable published specifications for a period of sixty (60) days from the date of Unipac's shipment.
- b. Goods or parts which have been subject to abuse (including without limitation repeated or extended exposure to conditions at or near the limits of applicable absolute ratings) misuse, accident, alteration, neglect, or unauthorized repair or improper application are not covered by any warranty. No warranty is made with respect to custom products or goods produced to Buyer's specifications (unless specifically stated in a writing signed by Unipac).
- c. No warranty is made with respect to goods used in devices intended for use in applications where failure to perform when properly used can reasonably be expected to result in significant injury (including, without limitation, navigation, aviation or nuclear equipment, or for surgical implant or to support or sustain life) and Buyer agrees to indemnify, defend, and hold harmless Unipac from all claims, damages and liabilities arising out of any such uses.
- d. This Paragraph 4 is the only warranty by Unipac with respect to goods and may not be modified or amended except in writing signed by an authorized officer of Unipac.
- e. Buyer acknowledges and agrees that it is not relying on any applications, diagrams or circuits contained in any literature, and Buyer will test all parts and applications under extended field and laboratory conditions. Notwithstanding any cross-reference or any statements of compatibility, functionality, interchangeability, and the like, the goods may differ from similar goods from other vendors in performance, function or operation, and in areas not contained in the written specifications, or as to ranges and conditions outside such specifications; and Buyer agrees that there are no warranties and that Unipac is not responsible for such things.
- f. EXCEPT AS PROVIDED ABOVE, UNIPAC MAKES NO WARRANTIES OR CONDITIONS, EXPRESS, IMPLIED, OR STATUTORY; AND UNIPAC EXPRESSLY EXCLUDES AND DISCLAIMS ANY WARRANTY OR CONDITION OF MERCHANTABILITY OR FITNESS FOR PARTICULAR PURPOSE OR APPLICATION.

5. LIMITATION OF LIABILITY

- a. Unipac will not be liable for any loss, damage or penalty resulting from causes beyond its reasonable control, including but not limited to delay by others, force majeure, acts of God, or labor conditions. In any such event, the date (s) for Unipac's performance will be deemed extended for a period equal to any delay resulting.
- b. THE LIABILITY OF UNIPAC ARISING OUT OF THIS CONTRACT OR ANY GOODS SOLD WILL BE LIMITED TO REFUND OF THE PURCHASE PRICE OR (WITH UNIPAC'S PRIOR WRITTEN CONSENT) REPAIR OR REPLACEMENT OF PURCHASED GOODS (RETURNED TO UNIPAC FREIGHT PRE-PAID).
- c. Buyer will not return any goods without first obtaining a customer return order number.
- d. AS A SEPARATE LIMITATION, IN NO EVENT WILL UNIPAC BE LIABLE FOR COSTS OF SUBSTITUTE GOODS; FOR ANY SPECIAL, CONSEQUENTIAL, INCIDENTAL OR INDIRECT DAMAGES; OR LOSS OF USE, OPPORTUNITY, MARKET POTENTIAL AND/OR PROFIT ON ANY THEORY (CONTRACT, TORT, FROM THIRD PARTY CLAIMS OR OTHERWISE). THESE LIMITATIONS SHALL APPLY NOTWITHSTANDING ANY FAILURE OF ESSENTIAL PURPOSE OF ANY REMEDY.

e. No action against Unipac, whether for breach, indemnification, contribution or otherwise, shall be commenced more than one year after the cause of action has accrued, or more than one year after either the Buyer, user or other person knew or with reasonable diligence should have known of the matter or of any claim of dissatisfaction or defect involved; and no such claim may be brought unless Unipac has first been given commercially reasonable notice, a full written explanation of all pertinent details, and a good faith opportunity to resolve the matter.

f. BUYER EXPRESSLY AGREES TO THE LIMITATIONS OF THIS PARAGRAPH 5 AND TO THEIR REASONABLENESS.

6. SUBSTITUTIONS AND MODIFICATIONS

Unipac may at any time make substitutions for product ordered which do not materially and adversely affect overall performance with the then current specifications in the typical and intended use. Unipac reserves the right to halt deliveries and shipments and alter specifications and prices without notice. Buyer shall verify that the literature and information is current before purchasing.

7. CANCELLATION

- a. This contract may not be canceled by Buyer except with written consent by Unipac and Buyer's payment of reasonable cancellation charges (including but not be limited to expenses already incurred for labor and material, overhead, commitments made by Unipac, and a reasonable profit).
- b. In no event will Buyer have rights in partially completed goods.

8. INDEMNIFICATION

Unipac will, at its own expense, assist Buyer with technical support and information in connection with any claim that any parts as shipped by Unipac under this purchase order infringe any valid, enforceable, unexpired R.O.C. patent, copyright, or trademark, provided however, that Buyer (i) gives immediate written notice to Unipac, (ii) permits Unipac to participate and to defend if Unipac requests to do so, and (iii) gives Unipac all needed information, assistance and authority. However, Unipac will not be responsible for infringements resulting from anything not entirely manufactured by Unipac, or from any combination with products, equipment, or materials not furnished by Unipac. Unipac will have no liability with respect to intellectual property matters arising out of products made to Buyer's specifications, code, or designs.

Except as expressly stated in this Paragraph 8 or in another writing signed by an authorized officer, Unipac makes no representations and/or warranties with respect to intellectual and/or industrial property and/or with respect to claims of infringement.

Except as to claims Unipac agrees in writing to defend, BUYER WILL INDEMNIFY, DEFEND AND HOLD HARMLESS UNIPAC FROM ALL CLAIMS, COSTS, LOSSES, AND DAMAGES (INCLUDING ATTORNEYS FEES) AGAINST AND/OR ARISING OUT OF GOODS SOLD AND/OR SHIPPED HEREUNDER.

9. NO CONFIDENTIAL INFORMATION

Unipac shall have no obligation to hold any information in confidence except as provided in a separate non-disclosure agreement signed by both parties.

10. ENTIRE AGREEMENT

- a. These terms and conditions are the entire agreement between Unipac and Buyer, and no addition, deletion or modification shall be binding on Unipac unless expressly agreed to in a writing signed by an officer of Unipac.
- b. Buyer is not relying upon any warranty or representation except for those specifically stated here.

11. APPLICABLE LAW

This contract and all performance and disputes arising out of or relating to goods involved will be governed by the laws of Taiwan, Republic of China, without reference to conflict of laws principles and excluding the U.N. Convention on Contracts for the International Sale of Goods. Buyer agrees at its sole expense to comply with all applicable laws in connection with the purchase, use or sale of the goods provided hereunder.

12. JURISDICTION AND VENUE

The courts located in Taiwan, Republic of China, will have the sole and exclusive jurisdiction and venue over any dispute arising out of or relating to this contract or any sale of goods hereunder, and Buyer hereby consents to the jurisdiction of such courts.

13. ATTORNEYS' FEES

Reasonable attorneys' fees and costs will be awarded to the prevailing party in the event of litigation involving the enforcement or interpretation of this contract.

